

RS485 RTS TRANSMITTER

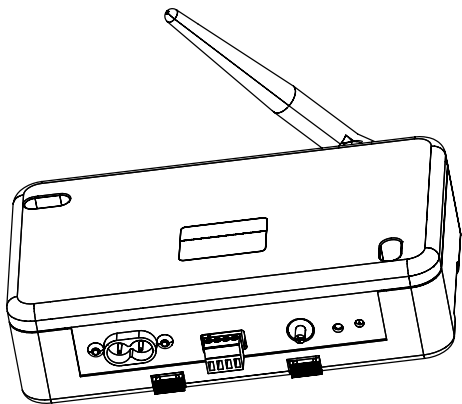

SOMFY hereby declares that this product complies with the essential requirements and other relevant provisions of Directive 1999/5/EC. A Declaration of Conformity is available at the web address www.somfy.com/CE. Suitable for use in EU, CH and NO.

SAFETY AND IMPORTANT INFORMATION

- This Somfy product must be installed by a professional motorisation and home automation installer, for whom these instructions are intended.
- Before installation, check that this product is compatible with the associated equipment and accessories.
- These instructions describe how to install, commission and use this product.
- Moreover, the installer must comply with current standards and legislation in the country in which the product is being installed, and inform his customers of the operating and maintenance conditions for the product.
- Any use outside the sphere of application specified by Somfy is not approved. Such use, or any failure to comply with the instructions given herein will invalidate the warranty, and Somfy refuses to accept liability.

PRODUCT DESCRIPTION

The RS485 RTS transmitter is a motor controller which allow to manage all your Somfy RTS applications with the same centralized home control system. It can control up to 16 groups of SOMFY RTS motors and receivers. It is impossible to set a motor or a receiver with this RS485 RTS transmitter. The RS485 RTS transmitter is for internal use only.

ENVIRONMENT



Damaged electric products and batteries should not be disposed of with normal household waste.

Make sure to drop them in specially provided containers or at an authorized organization that will ensure they are recycled.

INSTALLATION

Wall installation

DIN rail installation

WIRING

Controls wiring

- 1) For RS485 Control
Plug the RS485 control to the RS485 connector.

NC: Not Use

+ : RS 485 Bus +

- : RS 485 Bus -

G : Ground

- 2) For Dry Contact Control
Plug the dry contact control to the dry contact connector.

▼ : Down

▲ : Up

C : Commun

Power wiring

Connect the transmitter to a standard AC power source.

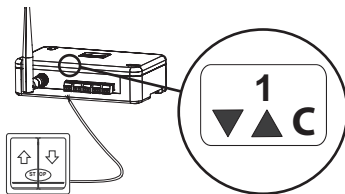
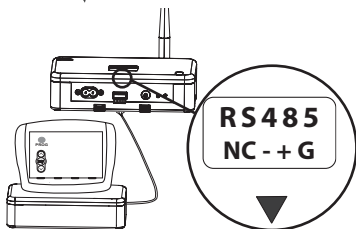
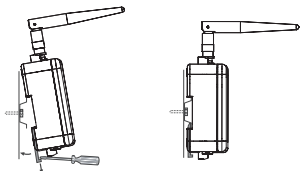
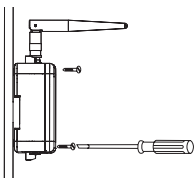

COMMISSIONING

Before assign a product to the transmitter, this product must be set.

Assign a product with a RS485 control

1) Press the programming button on the back of the RTS control point or the RTS receiver until the motor jogs.
The product is in programming mode.

2) Send by the RS485 control, the corresponding RTS frame on the desired channel.

The product is assigned to the transmitter's channel with a motor jog.

Assign a product with a DRY CONTACT control

1) Select the RTS address on the Channel selector corresponding to dry contact connectors.

- The dry contact connector n°1 has per default, the RTS address n°1
- The dry contact connector n°2 has per default, the RTS address n°2
-
-
- The dry contact connector n°5 has per default, the RTS address n°5

2) Press the programming button on the back of the RTS control point or the RTS receiver until the motor jogs.
The product is in programming mode.

3) Press the programming button on the RS485 RTS transmitter until the motor jogs.

The product is assigned to the transmitter.

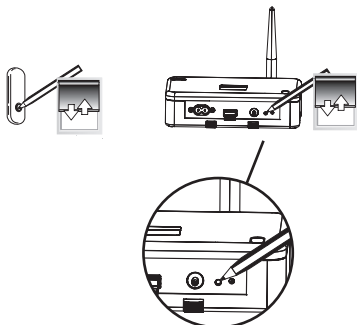
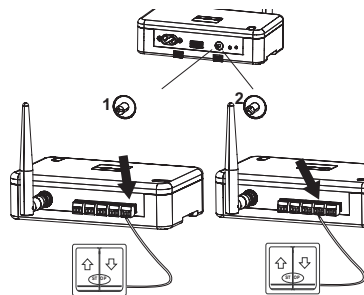
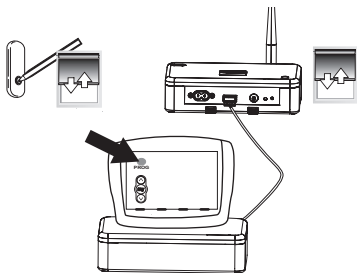

USE

Dry contact

Up, Down, Stop and My

Up

Press the Up button of the control

Down

Press the Down button of the control

Stop / My

Press the Stop button of the control.

If the product move, it will stop.

If the product don't move, the product goes to the My position (if a My position is recorded).

My position

1) Recording My position.

To set the My position, move the product to the desired position with the UP and DOWN buttons then press the My button until the shade jogs or the light blink.

2) Changing the My position

To change the My position go to the new desired My position with the UP and DOWN buttons then press the My button until the product jogs or the light blink.

3) Delete the My position

To delete the MY position, move to this position and press the My button until the product jogs or the light blink.

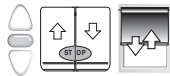
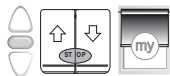
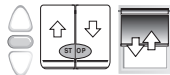
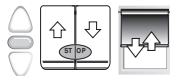
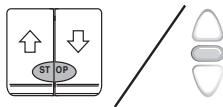
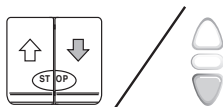

RS485 communication standard

All signals on the physical link between devices should comply with EIA/TIA-485-A standard.

Recommended cable : Shielded , two twisted- pair type 22 - 24 AWG (120 Ω)

Communication mode : half-duplex

Between two messages, leave 100 ms approx.

Each character is coded as follow :

Character coding		
Baud Rate	4800	+/-1%
Start bit	Logical Level 0	
Data bits	8	Less significant bit transmitted first
Parity	Odd	
Stop bit	Logical Level 1	

Message Format

Byte Number	Name	Value	Description
1	MSG	See Message Table	Refer to 'MSG' column in the table below for a list of available messages.
2	LEN		Refer to 'LEN' column to have the correct value depending on message.
3	Reserved	05h / 50h	Always 05h when message sent to RS485 RTS transmitter Always 50h when message received from RS485 RTS transmitter
4 - 6	SRC@(*) (**)	Node dependant (refer to product label)	NodeID of the transmitter (Source address)
7 - 9	DEST@(*) (**)		NodeID of the receiver (Destination address)
...	DATA	See Message Table	Information on DATA fields can be found below : <ul style="list-style-type: none"> - Length of DATA part (in byte count) - Type of every DATA fields - Available values for each DATA fields
Byte n-1	CHECKSUM	_____	CHECKSUM is one's complement of sum of bytes 1 to byte (n-2) if CHECKSUM not correct, message is ignored.
Byte n		Byte 1 + ... + Byte (n-2)	

(*) When the host is not a SOMFY product, its source address shall be included in the following values : FF FF 00 <= SRC@ <= FF FF FE
(**) Address values are LSBF.

Messages table

Command Type	Command Description	Message Name (MSG)
Setting	Configure application modes : <ul style="list-style-type: none"> - CE/US ergonomics - Rolling / Tilting mode - MODULIS mode 	SET_CHANNEL_MODE (90h)
	Set number of RTS frames to send on a CTRL_TILT order	SET_TILT_FRAMECOUNT (91h)
	Set number of RTS frames to send on a CTRL_DIM order	SET_DIM_FRAMECOUNT (92h)
	Sun Auto ON / OFF	SET_SUN_AUTO (93h)
	Lock / Unlock dry contacts inputs	SET_DCT_LOCK (94h)
	Send PROG command	SET_CHANNEL (97h)
	Open the programming mode	SET_OPEN_PROG (98h)
	Save favorite position as Intermediate Position	SET_IP (9Ah)

LEN	DATA Length	DATA Type	DATA Value
0Fh	4	8-bits	0 to 15 = RTS channel selection
		8-bits	0 = CE Mode 1 = US Mode (Default)
		8-bits	0 = Rolling Mode (Default) 1 = Tilting Mode
		8-bits	0 = Normal Mode 1 = Modulus Mode (Default)
0Eh	3	8-bits	0 to 15 = RTS channel selection
		8-bits	US mode (range = 4 to 255)
		8-bits	CE mode (range = 2 to 13)
0Dh	2	8-bits	0 to 15 = RTS channel selection
		8-bits	Range = 4 to 255
0Dh	2	8-bits	0 to 15 = RTS channel selection
		8-bits	0 = ON 1 = OFF
0Ch	1	8-bits	Bits 1 to 5 control inputs 1 to 5 0 = Unlock 1 = Lock
0Ch	1	8-bits	0 to 15 = RTS channel selection
0Ch	1	8-bits	0 to 15 = RTS channel selection
0Ch	1	8-bits	0 to 15 = RTS channel selection

Command Type	Command Description	Message Name (MSG)
Control	Move UP / Light ON Move DOWN / Light OFF STOP movement Move to favorite position / Switch light ON with favorite light level	CTRL_POSITION (80h)
	Tilt + / -	CTRL_TILT (81h)
	Dim + / -	CTRL_DIM (82h)

LEN	DATA Length	DATA Type	DATA Value
0Dh	2	8-bits	0 to 15 = RTS channel selection
		8-bits	1 = UP / ON 2 = DOWN / OFF 3 = STOP 4 = Favorite position / light level
0Eh	3	8-bits	0 to 15 = RTS channel selection
		8-bits	0 = Tilt + 1 = Tilt -
		8-bits	Tilting value (1 to 127)
0Eh	3	8-bits	0 to 15 = RTS channel selection
		8-bits	0 = Dim + 1 = Dim -
		8-bits	Diming value (1 to 127)

Command Type	Command Description	Message Name (MSG)
Status	Read application modes configuration	GET_CHANNEL_MODE (A0h)
	Answer to GET_CHANNEL_MODE	POST_CHANNEL_MODE (B0h)
	Read RTS frame count for CTRL_TILT order	GET_TILT_FRAMECOUNT (A1h)
	Answer to GET_TILT_FRAMECOUNT	POST_TILT_FRAMECOUNT (B1h)
	Read RTS frame count for CTRL_DIM order	GET_DIM_FRAMECOUNT (A2h)
	Answer to GET_DIM_FRAMECOUNT	POST_DIM_FRAMECOUNT (B2h)
	Read dry contacts lock configuration	GET_DCT_LOCK (A4h)
	Answer to GET_DCT_LOCK	POST_DCT_LOCK (B4h)

Warning: All messages named POST_Something are messages sent by the product as an answer to the corresponding GET_Something request. If POST_Something message is sent to the product, it will be ignored.

LEN	DATA Length	DATA Type	DATA Value
0Ch	1	8-bits	0 to 15 = RTS channel selection
0Fh	4	8-bits	0 to 15 = RTS channel selection
		8-bits	0 = CE Mode 1 = US Mode
		8-bits	0 = Rolling Mode 1 = Tilting Mode
		8-bits	0 = Normal Mode 1 = Modulus Mode
0Ch	1	8-bits	0 to 15 = RTS channel selection
0Eh	3	8-bits	0 to 15 = RTS channel selection
		8-bits	Frame count in US mode
		8-bits	Frame count in CE mode
0Ch	1	8-bits	0 to 15 = RTS channel selection
0Dh	2	8-bits	0 to 15 = RTS channel selection
		8-bits	Frame count
0Bh	0	n/a	
0Ch	1	8-bits	Bits 1 to 5 control inputs 1 to 5 0 = Unlock 1 = Lock

Example

Steps to follow to create a correct data frame :

1. Create frame with values as indicated in the tables above => «raw data»
2. Invert all data bytes => «actual data»
3. Calculate the checksum on «actual data» (sum of all inverted bytes)
4. Data to send are the concatenation of «actual data» and checksum

Steps to follow when receiving data from a product :

1. Received data are the concatenation of «actual data» and checksum
2. Remove the last 2 bytes to isolate the checksum and get «Actual data»
3. Invert all remaining data bytes to get the «raw data»

The following examples show the data to send on the bus for different message types. Examples are given for a communication between a host and a slave using the following addresses :

Host@ = FF:FF:00 (FF FF 00 <= @ <= FF FF FE for a non-SOMFY host)

Slave@ = 05:00:02 (See NodeID label on product)

Messages	Direction	Data
CTRL_POSITION Parameters : (Channel4, DOWN) >> Send DOWN command on channel 4	Command Host >> Slave	1. Raw data 2. Actual Data 3. Checksum 4. Data to send 80 0D 05 00 FF FF 02 00 05 04 02 7F F2 FA FF 00 00 FD FF FA FB FD 08 58 7F F2 FA FF 00 00 FD FF FA FB FD 08 58
CTRL_TILT Parameters : (Channel8, Tilt-, 30) >> Send a TILT command of -30 pulses	Command Host >> Slave	1. Raw data 2. Actual Data 3. Checksum 4. Data to send 81 0E 05 00 FF FF 02 00 05 08 01 1E 7E F1 FA FF 00 00 FD FF FA F7 FE E1 09 34 7E F1 FA FF 00 00 FD FF FA F7 FE E1 09 34
GET_CHANNEL_MODE Parameters : (Channel6) >> Read configuration of channel 6	Request Host >> Slave	1. Raw data 2. Actual Data 3. Checksum 4. Data to send A0 0C 05 00 FF FF 02 00 05 06 5F F3 FA FF 00 00 FD FF FA F9 07 3A 5F F3 FA FF 00 00 FD FF FA F9 07 3A
POST_CHANNEL_MODE Parameters : (Channel6, US, Rolling, MODULIS) >> Answer to the previous status request	Answer Slave >> Host	1. Received data 2. Actual data 3. Raw data 4F F0 AF FD FF FA FF 00 00 F9 FE FF FE 09 D7 4F F0 AF FD FF FA FF 00 00 F9 FE FF FE B0 0F 50 02 00 05 00 FF FF 06 01 00 01

RS485 command

for a blind

MOVE UP	Allow to open the blind.
MOVE DOWN	Allow to close the blind.
INTERMEDIATE POSITION	Allow to move the blind to the intermediate position.
STOP	Allow to stop the blind.
TILT +	Allow to move the venetian slats in one way.
TILT -	Allow to move the venetian slats in the other way.
SAVE FAVORITE POSITION AS INTERMEDIATE POSITION	Allow to record, change or delete an intermediate position. (cf : USE / My position p 5).
SUN AUTO ON	Allow to activate the sun automatism.
SUN AUTO OFF	Allow to deactivate the sun automatism.

for light

Light ON	Allow to switch on the light.
Light OFF	Allow to switch off the light.
ON (favourite light position)	Allow to switch on the light to a favorite level.
DIM +	Allow to increase the light intensity.
DIM -	Allow to decrease the light intensity.

TECHNICAL DATA

Voltage	90V → 255V
Voltage Frequency	50Hz → 60Hz
Operating temperature	0°C / 60 °C
Protection rating	IP20
Control	DCT / RS485
RTS Frequency	433 MHz

WWW.SOMFY.COM

Argentina: Somfy

Argentina

Tel: +55 11 (0) 4737-3700

Australia: Somfy PTY LTD

Tel: +61 (2) 8845 7200

Austria: Somfy GesmbH

Tel: +43 (0) 662 / 62 53 08 - 0

Belgium: Somfy Belux

Tel: +32 (0) 2 712 07 70

Brasil: Somfy Brasil Ltda

Tel: +55 11 3695 3585

Canada: Somfy ULC

Tel: +1 (0) 905 564 6446

China: Somfy China

Co. Ltd
Tel: +8621 (0) 6280 9660

Croatia : Somfy

Predstavništvo
Tel: +385 (0) 51 502 640

Cyprus : Somfy Middle East

Tel: +357(0) 25 34 55 40

Czech Republic:

Somfy, spol. s.r.o.
Tel: (+420) 296 372 486-7

Denmark: Somfy Nordic Danmark

Tel: +45 65 32 57 93

Export: Somfy Export

Tel: + 33 (0)4 50 96 70 76
Tel: + 33 (0)4 50 96 75 53

Finland: Somfy Nordic AB Finland

Tel: +358 (0)9 57 130 230

France : Somfy France Pour les professionnels :

Tel. : +33 (0) 820 374 374
Pour les particuliers :

Tel. : +33 (0) 810 055 055

Germany: Somfy GmbH

Tel: +49 (0) 7472 930 0
Greece: Somfy Hellas S.A.
Tel: +30 210 6146768

Hong Kong: Somfy Co. Ltd

Tel: +852 (0) 2523 6339

Hungary : Somfy Kft

Tel: +36 1814 5120

India: Somfy India PVT Ltd

Tel : +(91) 11 4165 9176

Indonesia: Somfy Jakarta

Tel: +(62) 21 719 3620

Iran: Somfy Iran

Tel: +98-217-7951036

Israel: Sisa Home Automation Ltd

Tel: +972 (0) 3 952 55 54

Italy: Somfy Italia s.r.l

Tel: +39-024847181

Japan: Somfy KK

Tel: +81 (0)45 481 6800

Jordan: Somfy Jordan

Tel: +962-6-5821615

Kingdom of Saudi Arabia: Somfy Saoudi

Riyadh :
Tel: +966 1 47 23 020
Tel: +966 1 47 23 203

Jeddah :
Tel: +966 2 69 83 353

Kuwait: Somfy Kuwait Tel: +965 4348906

Lebanon: Somfy Lebanon

Tel: +961 (0) 1 391 224

Malaysia: Somfy Malaysia

Tel: +60 (0) 3 228 74743

Mexico: Somfy Mexico SA de CV

Tel: 52 (55) 4777 7770

Morocco: Somfy Maroc

Tel: +212-22443500

Netherlands: Somfy BV

Tel: +31 (0) 23 55 44 900

Norway: Somfy Nordic Norge

Tel: +47 41 57 66 39

Poland: Somfy SP Z.O.O.

Tel: +48 (22) 50 95 300

Portugal: Somfy Portugal

Tel. +351 229 396 840

Romania: Somfy SRL

Tel.: +40 - (0)368 - 444 081

Russia: Somfy LLC.

Tel: +7 495 781 47 72

Serbia: SOMFY

Predstavništvo
Tel: 00381 (0) 25 841 510

Singapore: Somfy

PTE Ltd
Tel: +65 (0)6383 3855

Slovak republic: Somfy, spol. s r.o.

Tel: +421 337 718 638
Tel: +421 905 455 259

South Korea: Somfy JOO

Tel: +82 (0) 2594 4331

Spain: Somfy Espana SA

Tel: +34 (0) 934 800 900

Sweden: Somfy Nordic AB

Tel: +46 (0)40 16 59 00

Switzerland: Somfy A.G.

Tel: +41 (0) 44 838 40 30

Syria: Somfy Syria

Tel: +963-9-55580700

Taiwan: Somfy Development and Taiwan Branch

Tel: +886 (0) 2 8509 8934

Thailand: Bangkok

Regional office
Tel: +66 (0) 2714 3170

Thailand: Bangkok

Regional office
Tel: +66 (0) 2714 3170

Tunisia: Somfy Tunisia

Tel: +216-98303603

Turkey: Somfy Turkey-Mah.,

Tel: +90 (0) 216 651 30 15

United Arab Emirates:

Somfy Gulf Jebel Ali Free Zone

Tel: +971 (0) 4 88 32 808

Tel: +971 (0) 4 88 32 808

Tel: +971 (0) 4 88 32 808

United Kingdom:

Somfy Limited
Tel: +44 (0) 113 391 3030

United States: Somfy

Systems
Tel: +1 (0) 609 395 1300

